



Owner's Manual

3000 PSI

Pressure Washer



⚠ **WARNING!** To Reduce The Risk Of Injury, User Must Read And Understand Instruction Manual.

SP-WG300

FOR SERVICE CALL: 888-896-6881
PARA SERVICIO LLAME: 888-896-6881

www.steele-products.com

Table Of Contents

Topic	Page
Warranty	3
Safety Guidelines-Definitions	4
General Precautions	5
Safety Precautions	7
Pre-Start Preparation/Assembly	8
Operation	9
Detergent Connection	11
Maintenance	13
Trouble Shooting	15



WARNING! READ AND UNDERSTAND ALL SAFETY PRECAUTIONS IN THIS MANUAL BEFORE OPERATING. FAILURE TO COMPLY WITH INSTRUCTIONS IN THIS MANUAL COULD RESULT IN PERSONAL INJURY, PROPERTY DAMAGE, AND/ OR VOIDING OF YOUR WARRANTY. STEELE® PRODUCTS WILL NOT BE LIABLE FOR ANY DAMAGE BECAUSE OF FAILURE TO FOLLOW THESE INSTRUCTIONS.

Limited Warranty

Steele® warrants to the original purchaser who uses the product in a consumer application (personal, residential or household usage) that all products covered under this warranty are free from defects in material and workmanship for one year from the date of purchase. All products covered by this limited warranty which are used in commercial applications (i.e. income producing) are warranted to be free of defects in material and workmanship for 90 days from the date of original purchase. Products covered under this warranty include air compressors, air tools, service parts, pressure washers and generators.

Steele® will repair or replace, at Steele's® sole option, products or components which have failed within the warranty period. Service will be scheduled according to the normal work flow and business hours at the service center location, and the availability of replacement parts. All decisions of Steele® with regard to this limited warranty shall be final.

This warranty gives you specific legal rights, and you may also have other rights which vary from state to state.

RESPONSIBILITY OF ORIGINAL PURCHASER (initial User):

To process a warranty claim on this product, DO NOT return item to the retailer. The product must be evaluated by an Authorized Warranty Service Center. For the location of the nearest Authorized Warranty Service Center contact the retailer or place of purchase.

Retain original cash register sales receipt as proof of purchase for warranty to work.

Use reasonable care in the operation and maintenance of the product as described in the Owner's Manual(s).

Deliver or ship the product to the Authorized Warranty Service Center. Freight costs, if any must be paid by the purchaser. If the purchaser does not receive satisfactory results from the Authorized Warranty Service Center, the purchaser should contact Steele® toll free 888-896-6881.

THIS WARRANTY DOES NOT COVER:

Merchandise sold as reconditioned, used as rental equipment, or floor or display models.

Merchandise that has become damaged or inoperative because of ordinary wear, misuse, cold, heat, rain, excessive humidity, freeze damage, use of improper chemicals, negligence, accident, failure to operate the product in accordance with the instructions provided in the Owner's Manual(s) supplied with the product, improper maintenance, the use of accessories or attachments not recommended by Steele®, or unauthorized repair or alterations.

- Repair and transportation costs of merchandise determine not to be defective.
- Costs associated with assembly, required oil, adjustments or other installation and start-up costs. Expendable parts or accessories supplied with the product which are expected to become inoperative or unusable after a reasonable period of use.

Merchandise sold by Steele® which has been manufactured by and identified as the product of another company, such as gasoline engines. The product manufacturer's warranty, if any, will apply.

ANY INCIDENTAL, INDIRECT OR CONSEQUENTIAL LOSS, DAMAGE, OR EXPENSE THAT MAY RESULT FROM ANY DEFECTS, FAILURE OR MALFUNCTION OF THE PRODUCT IS NOT COVERED BY THIS WARRANTY. Some states do not allow the exclusion, so it may not apply to you.

IMPLIED WARRANTIES, INCLUDING THOSE OF MERCHANTABILITY OR FITNESS FOR A PARTICULAR PURPOSE, ARE LIMITED TO ONE YEAR FROM THE DATE OF ORIGINAL PURCHASE. Some states do not allow limitations on how long an implied warranty lasts, so the above limitations may not apply to you.

Safety Guidelines-Definitions



WARNING! Read and understand all safety precautions in this manual before operating. Failure to comply with instructions in this manual could result in personal injury, property damage, and / or voiding of your warranty. Steele® will not be liable for any damage because of failure to follow these instructions.

SAFETY SYMBOLS

The following symbols are used throughout this manual. Follow listed instructions to ensure your safety.

DANGER

Indicates an imminently hazardous situation which, if not avoided will result in serious injury or even death.



WARNING

Indicates an imminently hazardous situation which, if not avoided will result in serious injury or even death.



CAUTION

Indicates a potentially hazardous situation exists, which if not avoided, may result in minor or moderate injury or product damage.



NOTE

Indicates operation or maintenance information helpful to improve performance or operation.

General Precautions

PRESSURE WASHER

The following safety precautions apply whenever using, storing, or servicing your pressure washer to reduce the possibility of personal injury. Overlooking or ignoring these precautions can lead to personal injury or product damage.



- Read this manual carefully. Know your equipment. Consider applications, potential hazards and limitations for your unit.
- This equipment is designed for specific applications. Do not modify or use for any application other than which it is designed for.
- Store the pressure washer in a well ventilated area with the fuel tank empty. Fuel should not be stored near the pressure washer.
- Never operate pressure washer under these conditions:
 - a. A noticeable change in engine speed.
 - b. A noticeable loss of pressure.
 - c. Engine misfires.
 - d. Smoke or flames are present.
 - e. Enclosed area.
 - f. Excessive vibration.
 - g. Rain or bad weather.
- Water spray must never be directed towards people, pets, electric wiring, or directly towards the pressure washer.
- Do not allow the hose to come in contact with the hot muffler
- Equipment must be placed on a firm supporting surface.
- Remove the spark plug or cable from the spark plug to prevent accidental starting when not in use, or prior to detaching the high pressure hose.

General Precautions

- Keep the pressure washer clean and free of oil, mud and other foreign matter.
- Do not wear loose clothing, jewelry, or anything that may be caught in the engine.
- Never direct spray at people or animals.
- Never allow children to operate pressure washer at any time.
- Use both hands to control the wand.
- Do not touch the nozzle or water spray while operating.
- Wear safety goggles while operating.
- Only approved hoses and nozzles should be used.
- Do not kink the high pressure hose.
- All hose connections must be properly sealed.
- In extremely cold conditions, prior to starting be sure ice has not formed in any part of the pressure washer.
- Use only recommended chemicals.
- Outdoor use only.
- Place pressure washer away from cleaning site during operation.
- To prevent accidental discharge, the spray gun should be secured by locking the trigger when not in use.
- Do not run the pressure washer more than 5 minutes without depressing the trigger or damage to the pump may occur.
- Check the pressure washers periodically for damage, leaks or signs of deterioration. All defects should be corrected before operating the pressure washer.

General Precautions

- Do not touch hot muffler.
- Service, operate and refuel under the following conditions:
 - a. Good ventilation
 - b. Refuel the pressure washer in a well lit area.
 - c. Avoid fuel spills and never refuel while the pressure washer is running.
 - d. Avoid any ignition source when refueling.
 - e. Use lead free fuel with a minimum of 85 octane.
- Do not smoke near pressure washer.
- Do not operate under 40° fahrenheit.

SAFETY FEATURES

Thermal Relief Valve

A thermal relief valve is provided to protect the pump from overheating if the spray gun is closed for an extended amount of time or the nozzle becomes plugged. However, it is intended to be used as a backup system and every effort should be made to not permit the pump to heat up.

We recommend to turn the pressure washer OFF if it will not be used for more than 5 minutes. This saves wear on the unit, reduces fuel consumption and extends the life of the pump by avoiding overheating.

Safety Lock Latch

To prevent accidental discharge of high pressure water, the safety latch on the trigger should be engaged whenever the pressure washer is not in use.

Low-Oil Shutdown

Some engines are equipped with low-oil shutdown systems. If the engine oil level becomes lower than required, the pressure washer will automatically shut off. Refer to the engine manual for this feature. This protects your pressure washer engine from operating without proper lubrication.

If the pressure washer engine shuts off and the oil level is according to specification, check to see if the pressure washer is sitting on an angle that forces the oil to shift. Place on even surface to correct this. If the engine fails to start, the oil may not be sufficient to deactivate the low oil level switch. Be sure the pump oil level is correct.

Pump will overheat and may be damaged, or cause damage if allowed to circulate more than 5 minutes



Pre-Start Preparation/Assembly

BEFORE OPERATION

NOTE: The engine and pump on your pressure washer will often have improved performance after a break-in period of several hours.

PRE-START PREPERATION

Before starting the pressure washer, check for loose or missing parts and for any damage which may have occurred during shipping.

ASSEMBLY & START-UP

Hose & Gun Assembly

NOTE: Align threaded connections carefully to prevent damaging threads during assembly. Tighten connections securely to prevent leaks during operation.

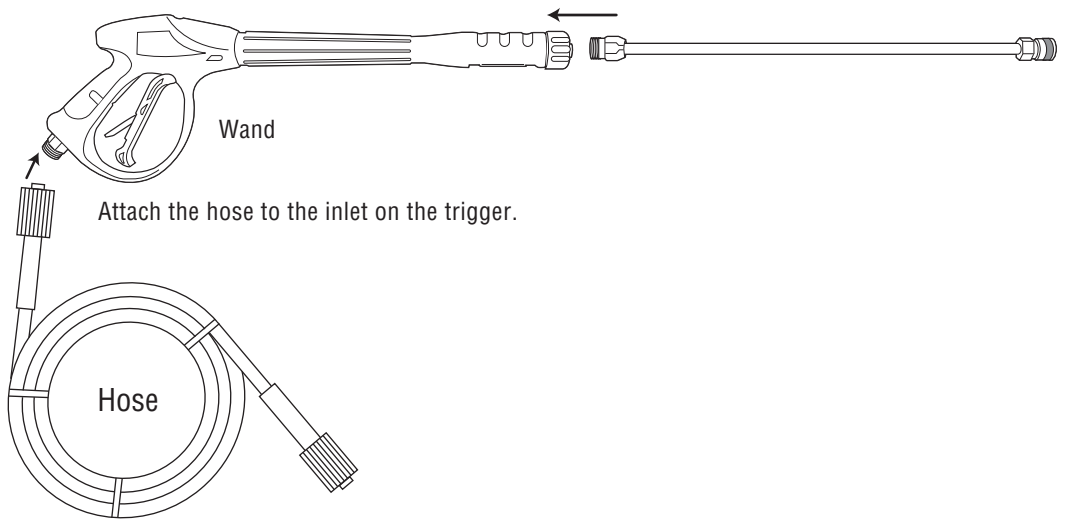

LUBRICATION

Do not attempt to start the pressure washer engine without filling the engine crank case with the proper amount of oil. Your pressure washer has been shipped without oil in the crankcase. Operating the pressure washer without oil will ruin the engine. Use oil that is recommended (10W-30). **DO NOT OVERFILL!**

FUEL

Fill the tank with unleaded gasoline. Regular gasoline may be used provided a high octane rating is obtained (at least 85 octane).



Gasoline is highly flammable and explosive and you can be burned or seriously injured when refueling if not carefull.

Operation

OPERATING CONNECTIONS

High Pressure Hose

- Attach the high pressure hose to the pressure washer by pulling back on the collar of the quick-connect coupling on the hose and pushing it over the coupling half on the pressure washer outlet.

NOTE: Do not use pressure hose from another manufacturer.

WATER CONNECTION

Before connecting the garden hose to your pressure washer, run water through the garden hose (not supplied) to flush out any foreign matter.

- Attach garden hose quick-connect to the garden hose (see below).
- Then attach that to the quick-connect inlet on the pressure washer pump. Make sure it locks into place by pulling back on the garden hose quick-connect collar and inserting it into the quick-connect inlet.

NOTE: The water supply must supply a minimum of 4 gpm at 20 PSI, or the pump can be damaged.

PRESSURE WASHER PUMP

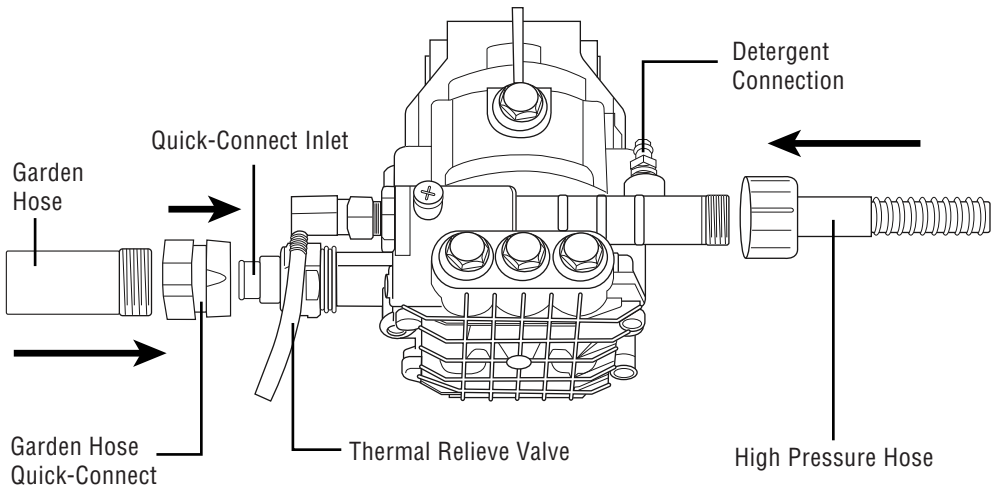

Operation

OPERATING INSTRUCTIONS

Start-up Procedure

1. Make sure water supply is connected and turned on.
2. Release gun safety if locked.
3. To allow air to escape from the hose, squeeze trigger on the gun until there is a steady flow of water coming out from the nozzle.

Starting Engine

1. Check oil and gas.
2. Connect hose and turn on water.
3. Squeeze trigger.
4. Make sure the pressure washer is on the ON position (illustration 1).
5. Set the fuel valve to open (illustration 2).
6. Set choke if available (illustration 3) & set throttle to slow (illustration 4).
7. When starting engine, pull cord slowly until resistance is felt, then pull rapidly.
8. If engines starts and fails to continue running or if increase resistance is felt during starting pull attempts repeat step 3 - 7.

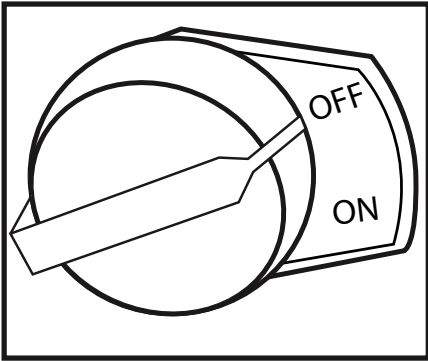

1) ON/OFF Switch

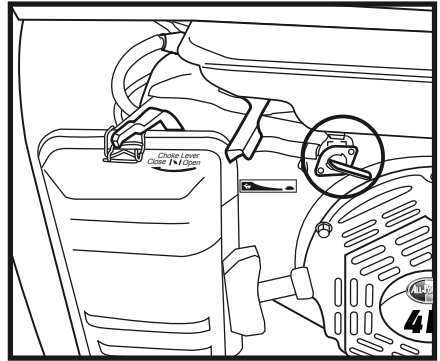

2) Fuel Valve

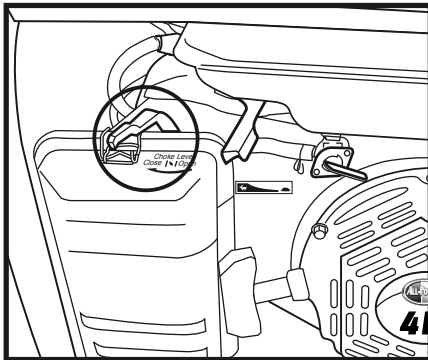

3) Choke

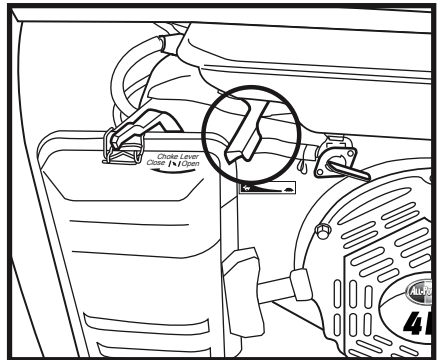

4) Throttle Control

Detergent Connection

CAUTION!

This pressure washer is intended for use only with liquid car wash detergents, developed specifically for pressure washers and with mild soaps. Only use chemicals compatible with the aluminum and brass parts. Powdered soaps may clog the injection system. Always use chemicals according to the manufacturers directions. We assume no responsibility for any damages caused by chemicals injected through this pressure washer.

1. Attach injection tube assembly to the detergent connection on the pump.
2. Open a container of chemicals and place next to the unit near the injection tube.
3. Visually inspect strainer at the end of the injection tube to verify that it is not clogged
4. Insert the injection tube into the container all the way to the bottom.
5. Remove the high pressure nozzle from the wand and install the black injection nozzle.

The solution will automatically mix with the water and discharge through the nozzle.

NOTE: For certain models, if the engine throttle is not in the fast position, the injection of the solution may be decreased or stopped.

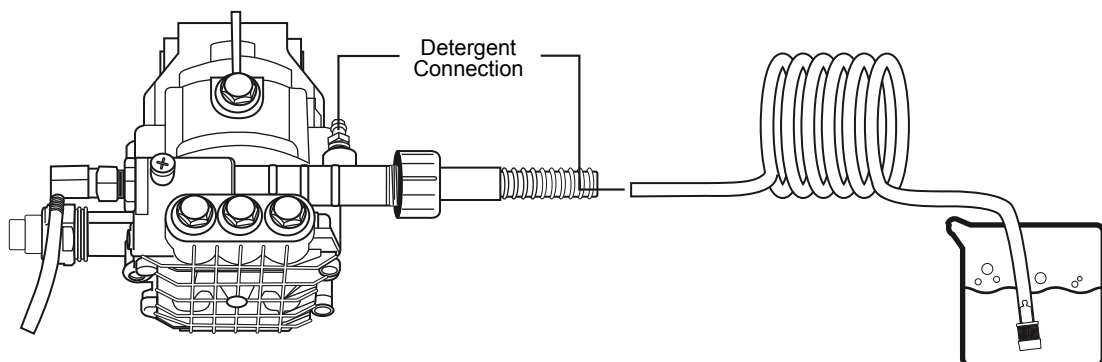

CLEANING TECHNIQUES

When cleaning with the pressure washer, many cleaning tasks can be solved with water alone, but for most tasks, it is advantageous to use a detergent. A detergent ensures a quick soaking of the dirt allowing the high pressure water to penetrate and remove the dirt more effectively.

APPLICATION OF SOAP OR DEGREASER

1. Apply the solution to the dry work surface. On a vertical surface, apply horizontally from side to side starting from bottom to avoid streaking.

NOTE: Wetting the surface first is not recommended, it dilutes the detergent and reduces its cleaning effects.

Detergent Connection/Usage

OPERATION

Avoid working on hot surfaces or in direct sunlight to minimize the chances of the chemical damaging painted surfaces. Damage may occur to painted surfaces if the chemical is allowed to dry on the surface. Hold the nozzle far enough away from surface to prevent damage to the surface.

2. Allow chemical to remain on the surface for a short time before rinsing.
3. Rinse with clean water under high pressure. On a vertical surface, first rinse from the bottom up, then rinse from top down. Hold nozzle 6 to 8 inches from the work surface at a 45° angle using the flat spray as a peeling tool rather than a scrub brush.

APPLICATION OF WAX

1. Immediately after cleaning, apply wax. Place injection tube in container of wax.
2. Apply the wax sparingly in an even layer. Apply to wet surfaces from bottom up for even distribution and to avoid streaking.
3. Remove the suction tube from the wax bottle rinse off the surplus wax.

NOTE: If surplus wax is not removed, a hazy finish may result.

4. Wipe dry to reduce water spotting.

END OF OPERATION

When you have completed use of chemical injection system, remove tube from container. Continue to run in low pressure position and inject clean water through the tube and injection system by placing end of tube in a container of clean water. Continue to run until it is thoroughly cleaned.

MAINTENANCE

Connections

Connection on pressure washer hoses, gun and spray wand should be cleaned regularly and lubricated with the manufacturers recommended grease to prevent leakage and damage to the O-rings.

NOZZLE

Clogging of the nozzle causes the pump pressure to be too high, cleaning is immediately required.



A nozzle cleaner must only be used when the spray wand is disconnected from the gun or personal injury may occur.

1. Separate the wand from the gun.

Maintenance

MAINTENANCE

2. Clear the nozzle with a small rigid piece of wire such as a paper clip.
3. Flush the nozzle backwards with water.
4. Reconnect the wand to the gun.

Restart the pressure washer and depress the trigger on the spray gun. If the nozzle is still plugged or partially plugged, repeat above instructions 1-4.

If the previous procedure does not clear the nozzle, replace with a new nozzle.

WATER SCREEN

The pressure washer is equipped with a water inlet screen to protect the pump. If the screen is not kept clean, it will restrict the flow of water to the pressure washer and may cause damage to the pump. Do not damage screen when cleaning it. Any foreign particles entering the pump may damage the pump. Do not operate pressure washer without the screen in place. Remove the screen and backflush to remove impurities from screen. Replace immediately.

ENGINE MAINTENANCE

During the winter months, rare atmospheric conditions may develop which will cause an icing condition in the carburetor. If this develops, the engine may run rough, lose power and may stall. This temporary condition can be overcome by deflecting some of the hot air from the engine over the carburetor area.

STORAGE

Pump Storage

If you must store your pressure washer in a location where the temperature is below 32° F, you can minimize the chance of damage to your machine by utilizing the following procedure:

1. Shut off water supply and relieve pressure to the spray gun by depressing the trigger.
2. Disconnect the garden hose from the pressure washer, but leave the high pressure hose connected.
3. Tip the unit on its side with the inlet connection pointing up.
4. Insert a small funnel (to prevent spilling) into the inlet and pour in approximately 1/4 cup of antifreeze.
5. Disconnect spark plug wire.
6. Without connecting garden hose pull the recoil several times to circulate the antifreeze in the pump system.
7. Disconnect spark plug wire.

CAUTION! Prior to starting, thaw out any possible ice from the pressure washer hoses, spray gun and wand.

Maintenance

Another method of reducing risks of freeze damage is to drain your pressure washer as follows:

1. Stop the pressure washer and detach supply hose and high pressure hose. Squeeze the trigger of the discharge gun to drain all water from the wand and hose.
2. Restart the pressure washer and let it run briefly about 5 seconds) until water no longer discharges from the high pressure outlet.

ENGINE STORAGE

When the pressure washer is not being used or is being stored for more than a month follow these instructions:

1. Replenish engine oil to upper level.
2. Drain gasoline from fuel tank, fuel line, fuel valve and carburetor.
3. Pour about one teaspoon of engine oil through the sparkplug hole, pull the recoil starter slowly until you feel increase pressure which indicates the piston is on its compression stroke and leave it in the position. This closes both the intake and exhaust valves to prevent the inside of the cylinder from rusting.
4. Cover the pressure washer and store in a clean, dry place that is well ventilated away from open flame or sparks.

NOTE: The use of a fuel additive, such as STA-BIL, or an equivalent, will minimize the formulation of fuel gum deposits during storage.

Technical Specification

Maximum Inlet Pressure	Up To 90 PSI
RPM	3600 RPM
Temperature OF Pumped Fluids	Up To 80 F
Inlet Ports	(2) 1/2 inch BSP
Discharge Ports	(2) 1/2 inch BSP
Weight	92.4 lbs.
Engine Oil	10W-30
HP	6.5HP
Fuel	Unleaded Gas

Trouble Shooting

- Engine will not start or stops while operating.
 - Low-oil shutdown:
 - Engine switch not in "ON" position:
 - Pressure built up in hose:

Fill engine with oil
Turn switch "ON"
Squeeze trigger while starting
- Engine is overloaded
 - Nozzle partially blocked
 - Excessive pressure

Clean Nozzle
Shorten the spring coil on the reflux valve
- Pressure increases when gun is locked
 - Bypass valve blocking

Clean the bypass valve
- Engine is running but pump won't build maximum pressure or has irregular pressure
 - Faucet closed
 - Unit has been stored in freezing temp.
 - Inadequate water supply
 - Water inlet screen clogged
 - Kink in garden hose
 - Wand nozzle worn or damaged
 - Air in pump

Open faucet
Thaw out unit completely
Provide a minimum of 4 GPM at 20 PSI
Clean screen
Straighten garden hose
Replace nozzle
Run with gun open & wand removed until steady stream of water is released
Set to maximum position

 - Adjustable pressure knob not set to maximum position
 - Suction or discharge valves clogged or worn out
 - Bypass valve not operating effectively

Clean the suction or discharge valves
Clean the bypass valve
- No intake of chemicals
 - Injection tube not securely inserted into unit
 - Tube cracked or split
 - Wrong nozzle
 - Injector turned off

Push firmly into injector
Replace tube
Switch to low pressure nozzle
Turn collar counter
- Trigger will not move
 - Gun safety lock engaged

Release safety lock

Trouble Shooting

- Water in crankcase
 - High humidity
 - Worn seals

Change oil more frequently
Change the oil seals
- Noisy operation
 - Worn bearings
 - Air mixed with water

Change the bearings
Check inlet lines for restrictions
and / or proper sizing
- Rough / pulsating, operating with pressure drop
 - Inlet restriction
 - Unloader
 - Air mix in water

Check system for stoppages, air leaks,
correctly sized inlet plumbing to pump
Check unloader for proper operation
Check inlet lines for restrictions and or
proper sizing
- High crankcase temperatures
 - Wrong grade of oil
 - Improper amount of
oil in crankcase

Use recommended oil

Adjust oil to proper amount